

# **Электрофизиологические методы исследований**

**Nikolai I. Kononenko**

Department of General Physiology of Nervous System,  
Bogomoletz Institute of Physiology,  
Kiev, Ukraine

1.

▪

2.

«Patch-clamp».

3.

▪

4.

▪

# The squid and its giant axon

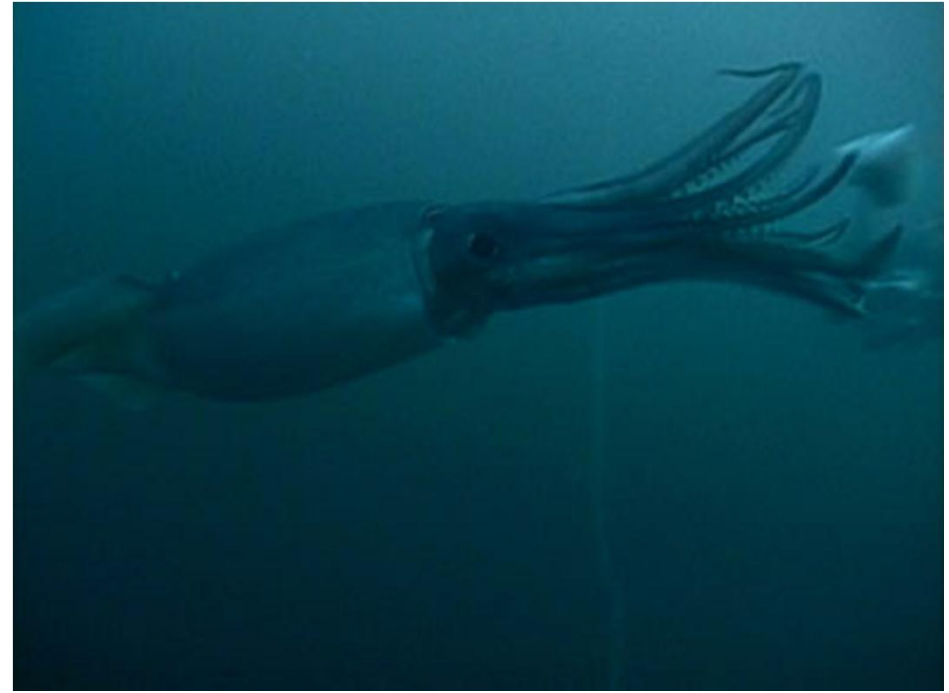
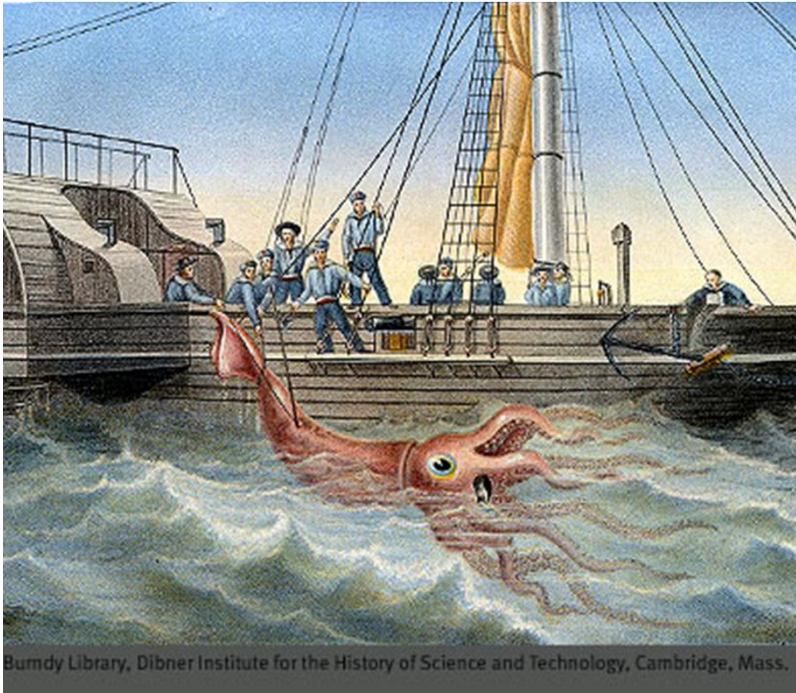

# Action potential in squid axon

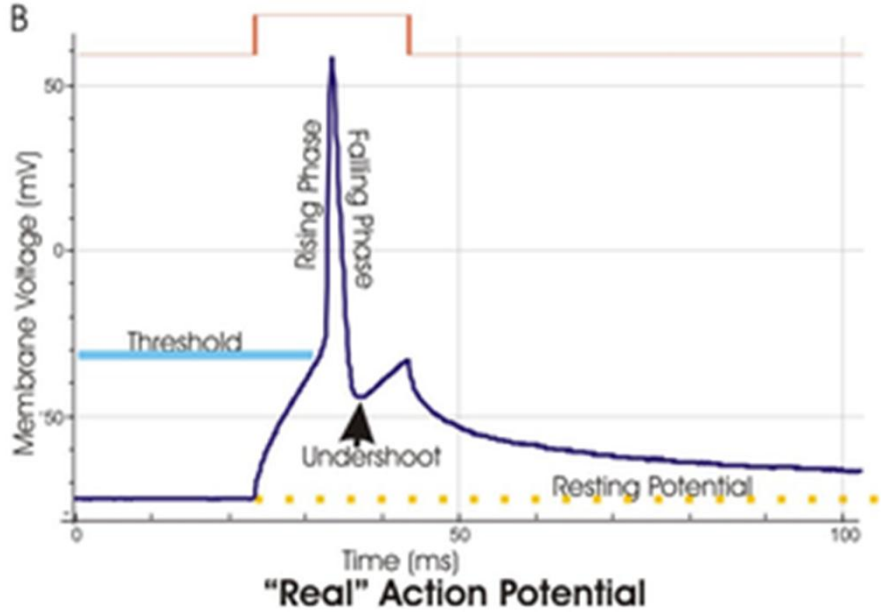
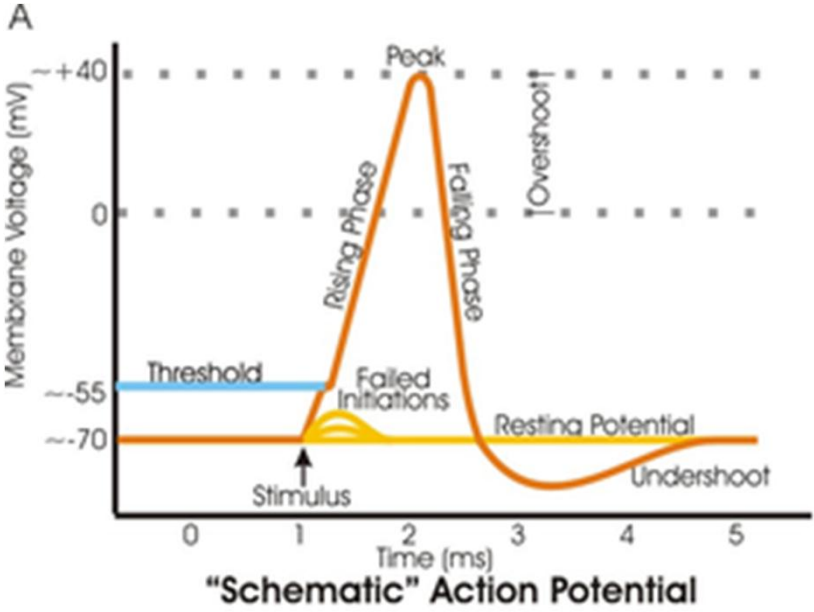
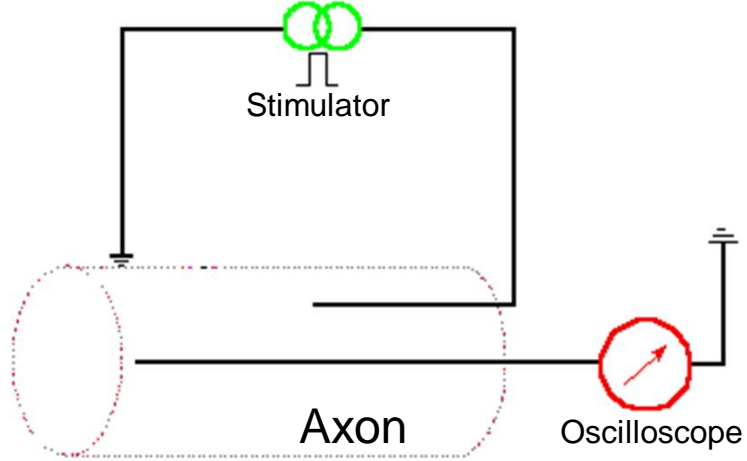
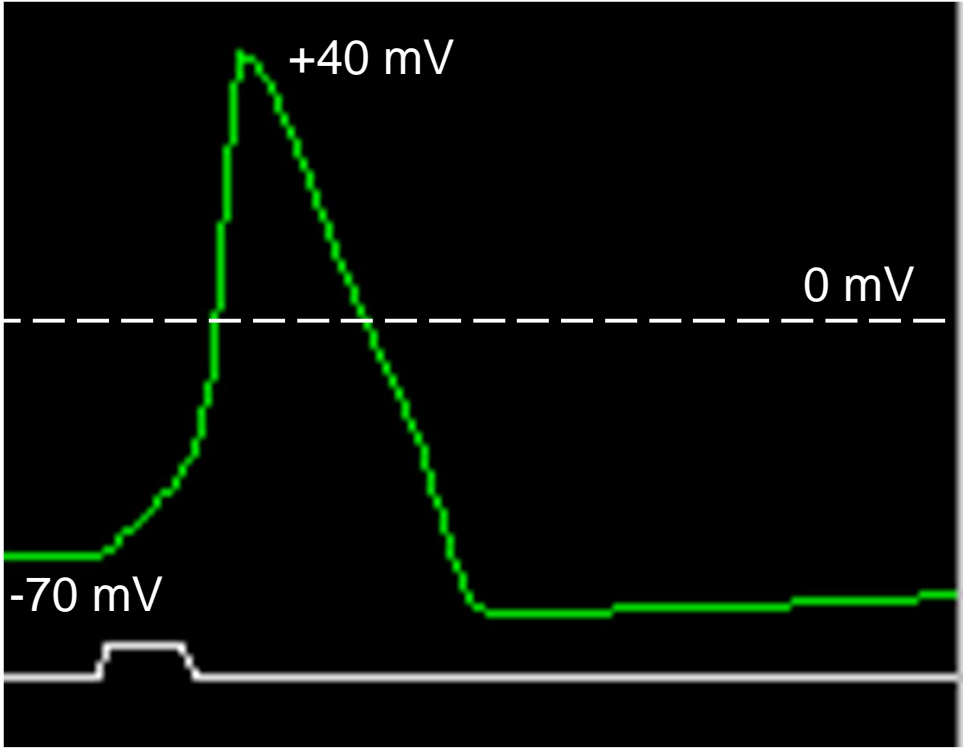

# Voltage clamp of squid axon, tetrodotoxin and Na current

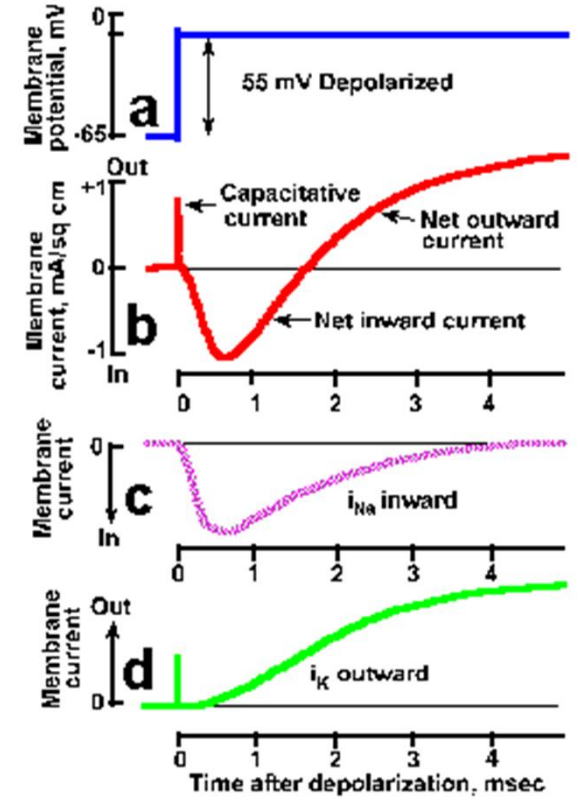
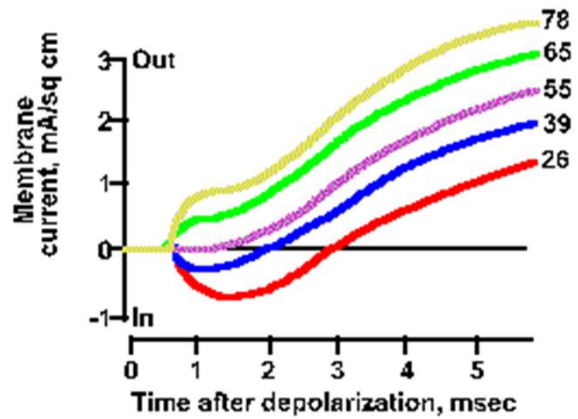
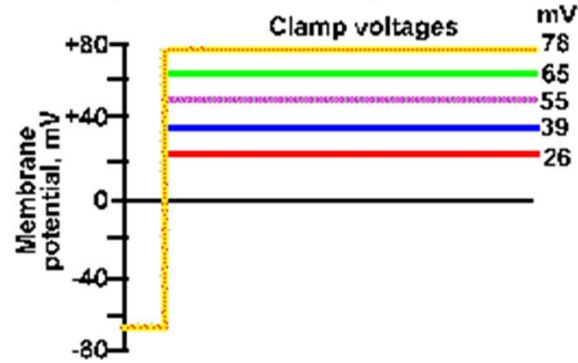
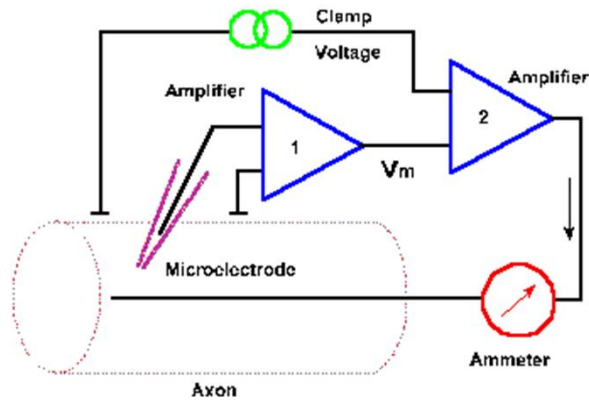

Tetrodotoxin (TTX)

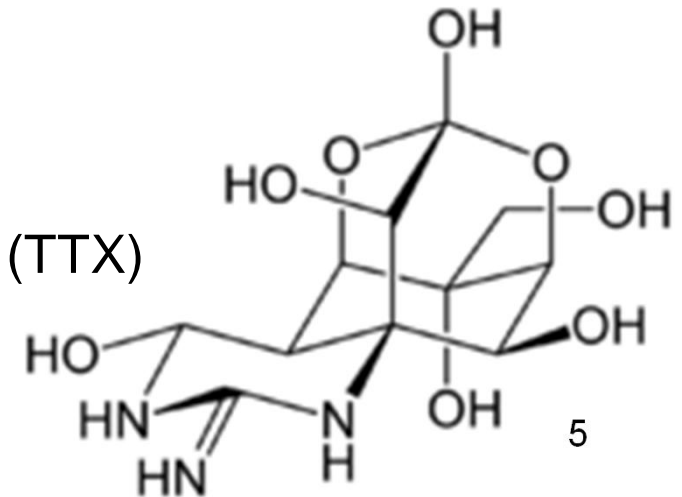

Negative resistance region, negative conductance, negative slope

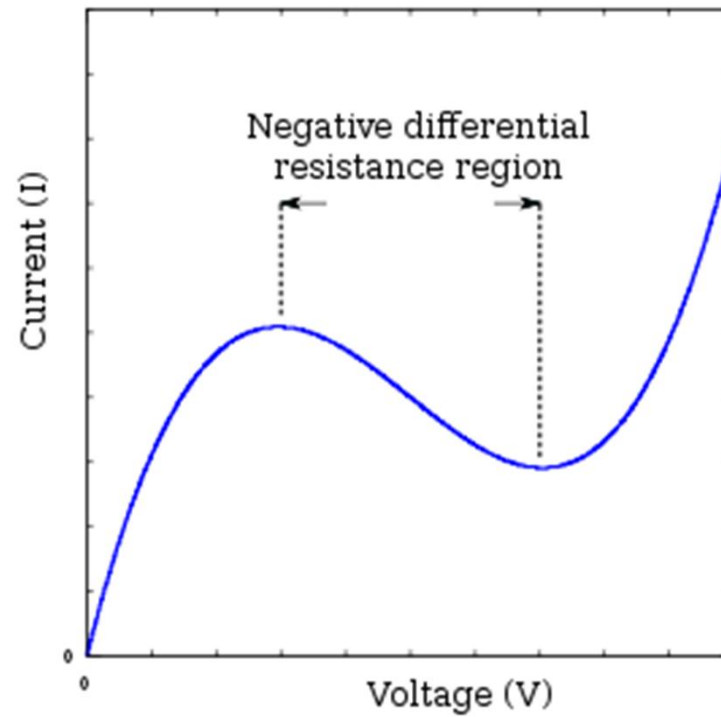
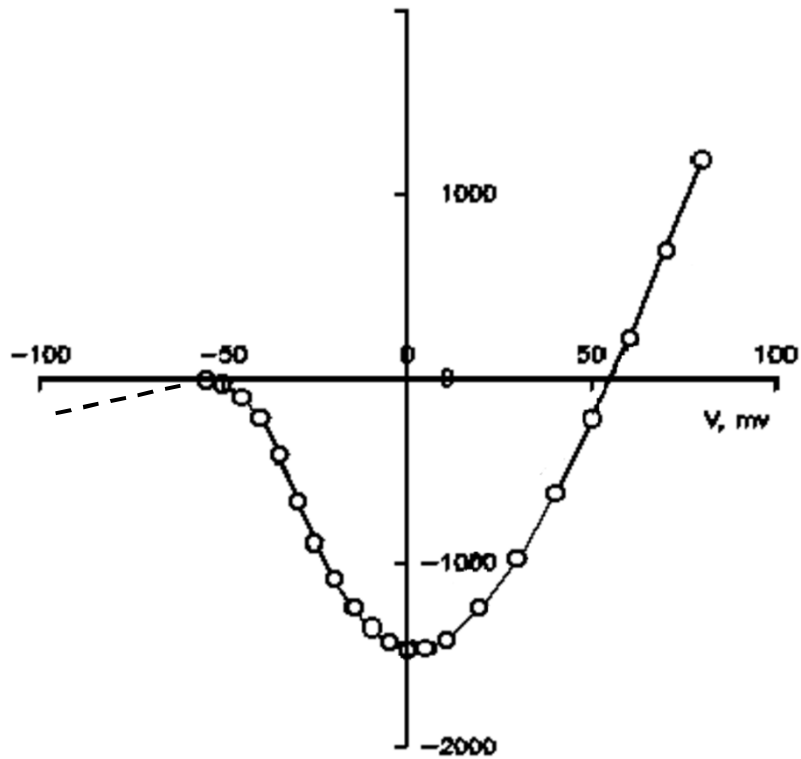

# Neuron and voltage clamp of its membrane

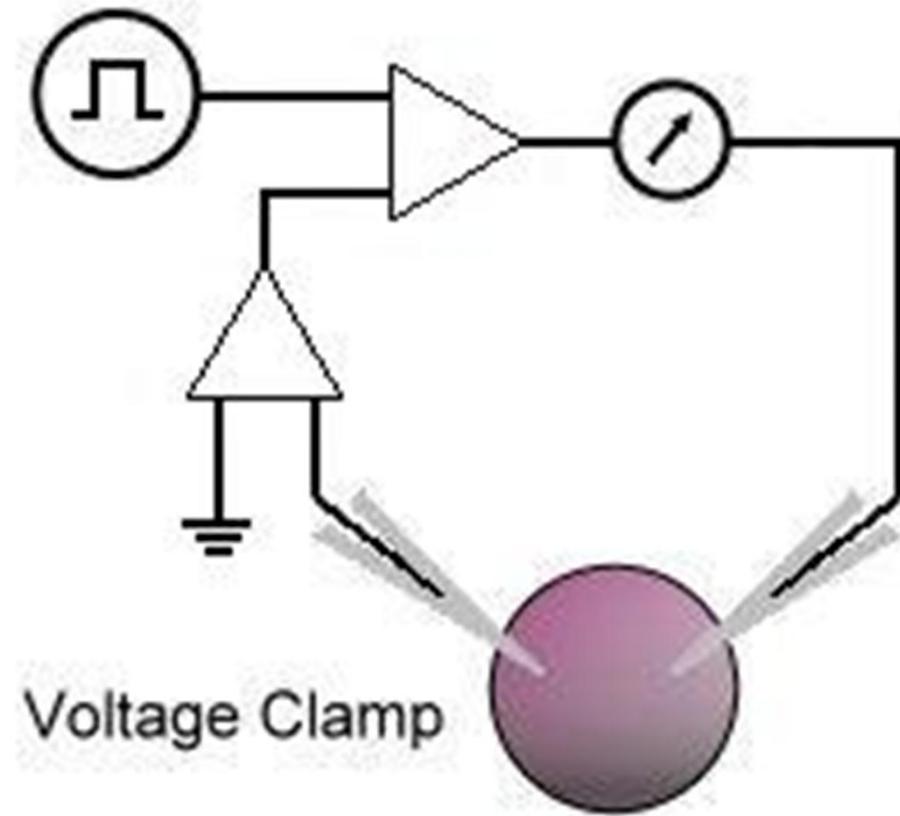
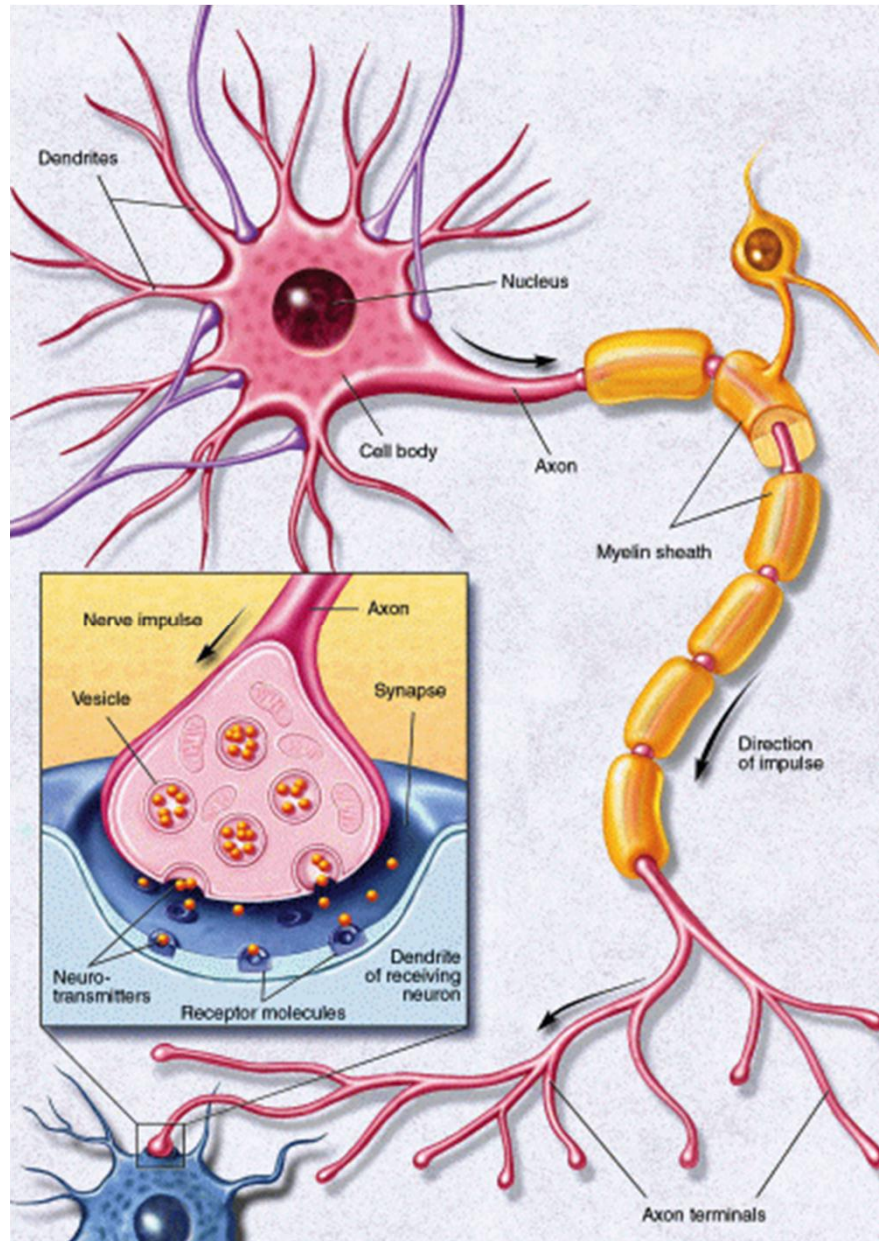

# Aplysia and its giant neurons

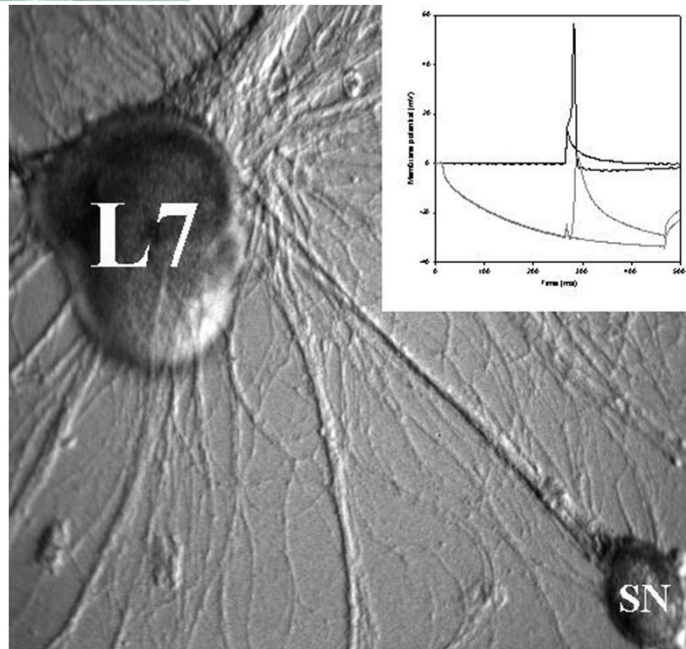
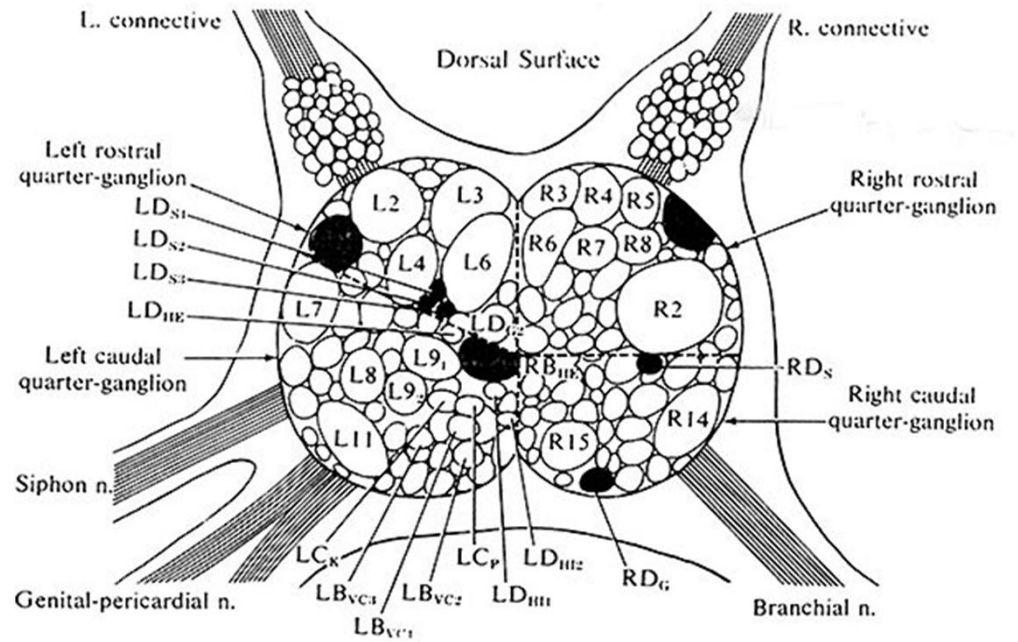



# Three modes of patch clamping



## Patch clamp recording

---

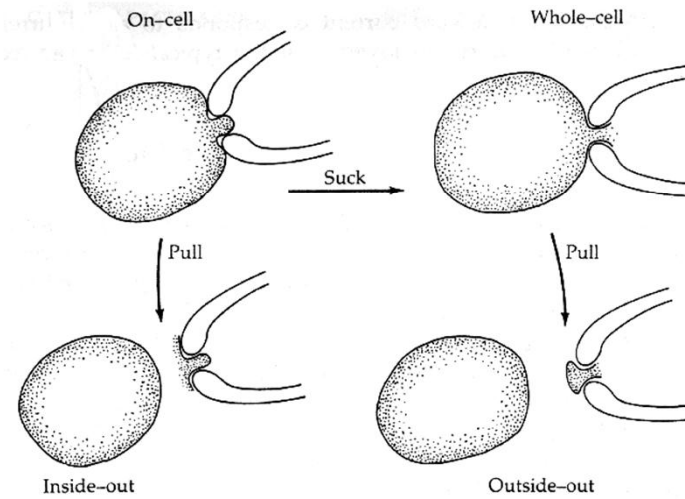

# Patch clamp recording of somal sodium currents from Purkinje neurons in slice preparation.

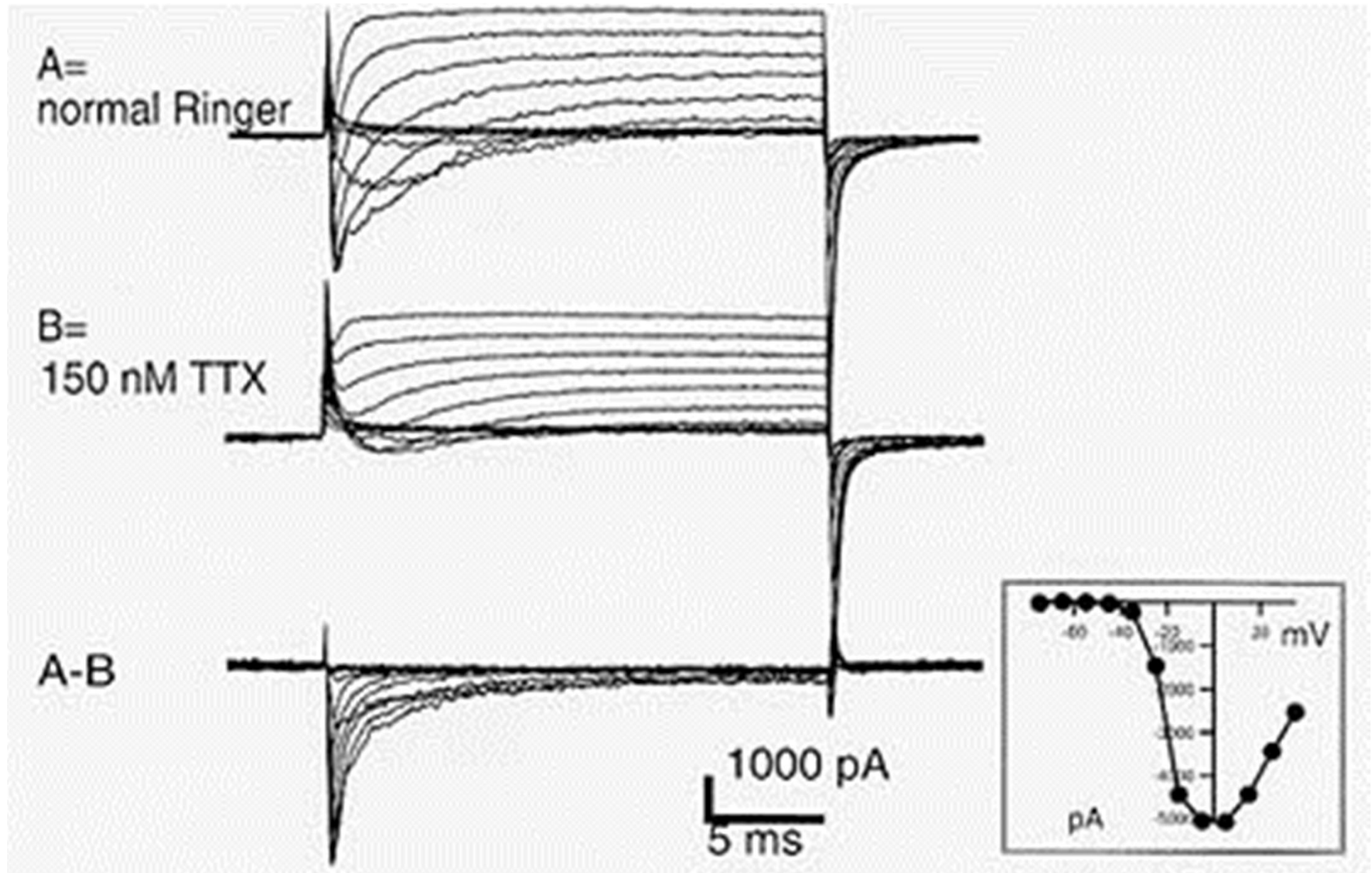

# On-cell recording of single channels

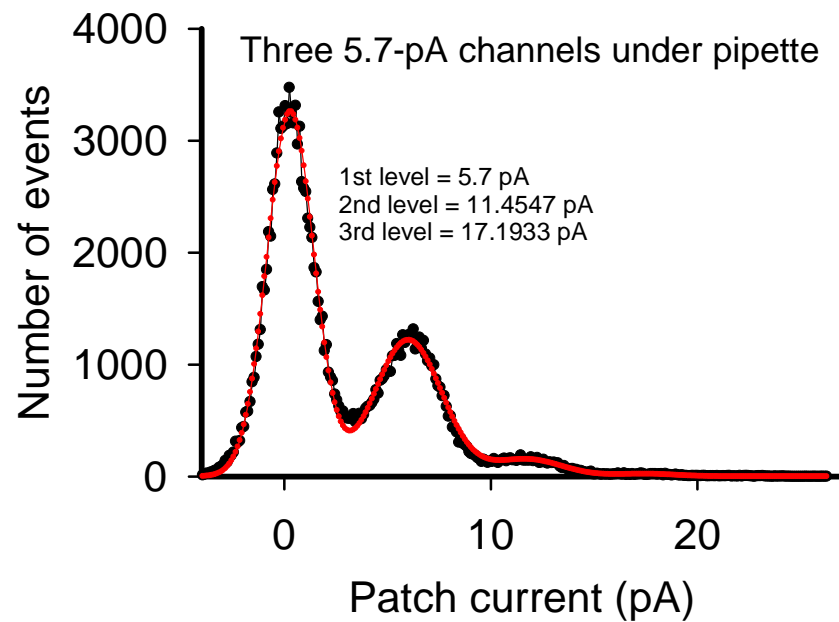
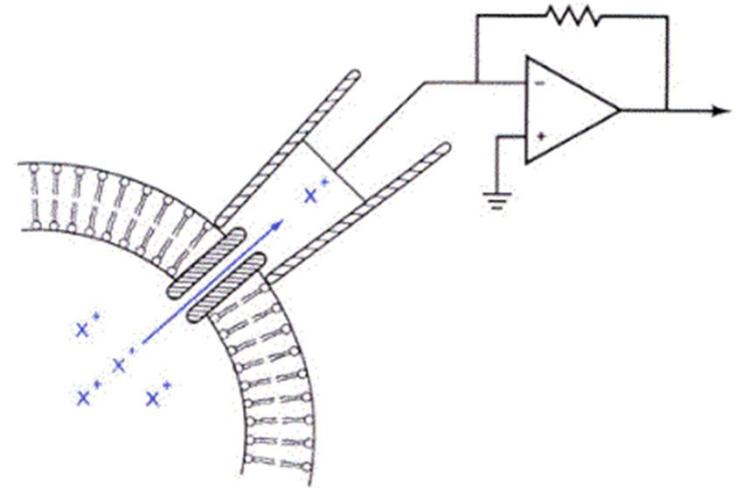
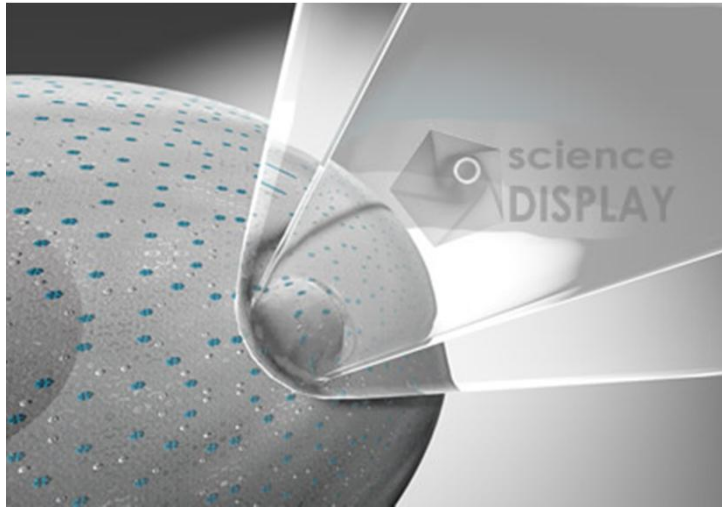

From 14  
Rat CA1 neuron

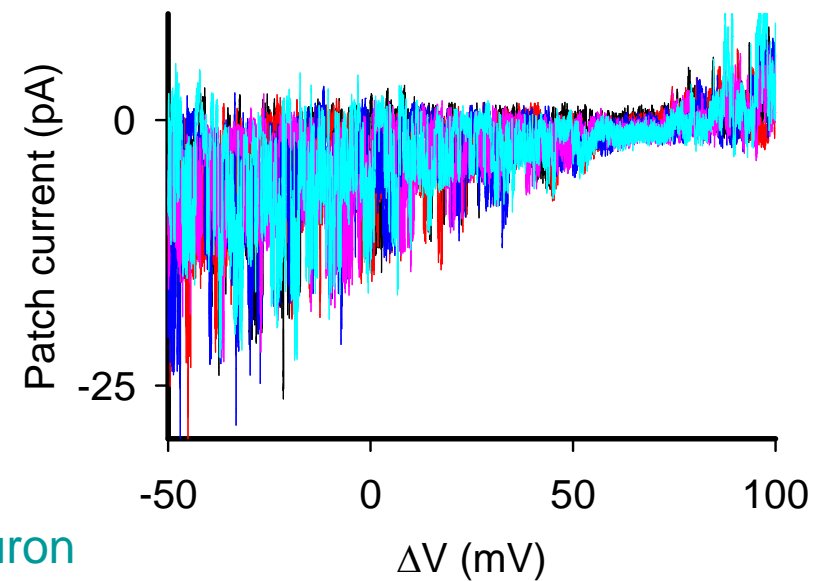

# Multielectrode array dish (MED)

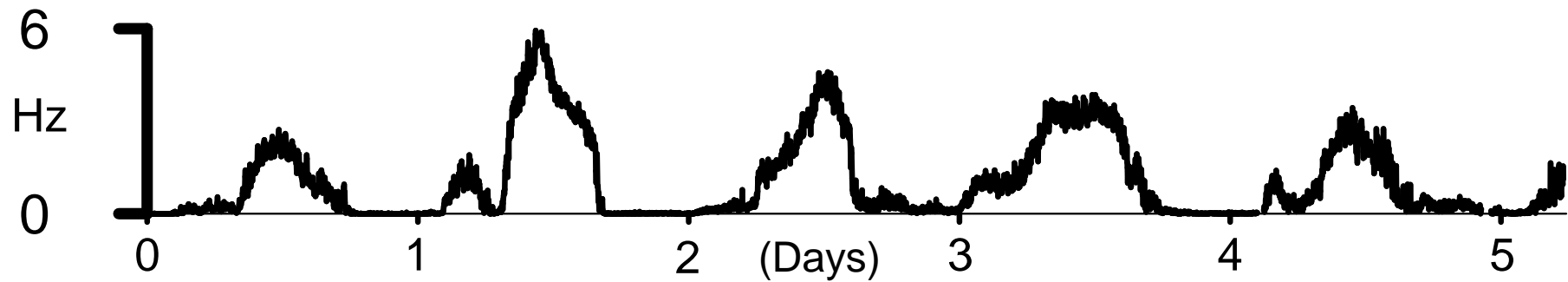
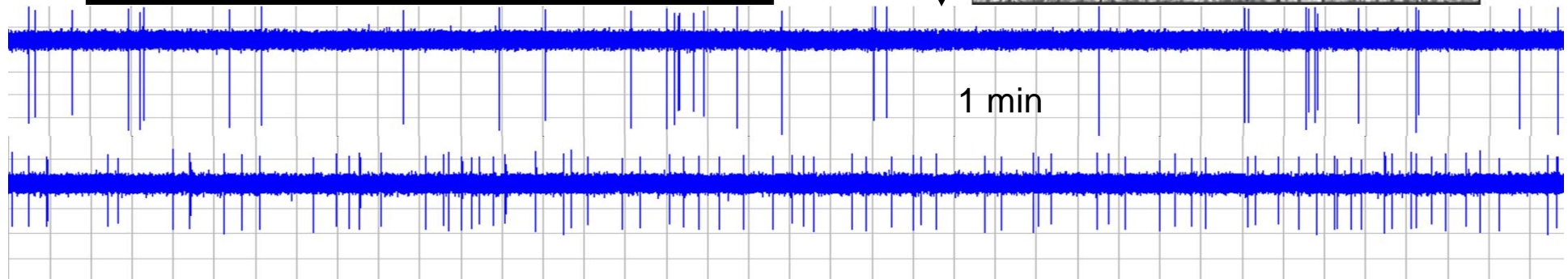
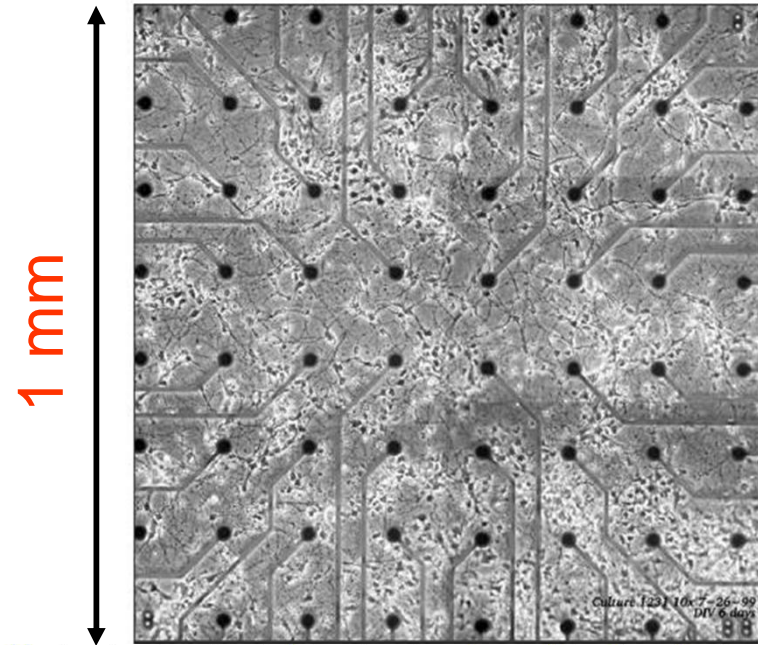
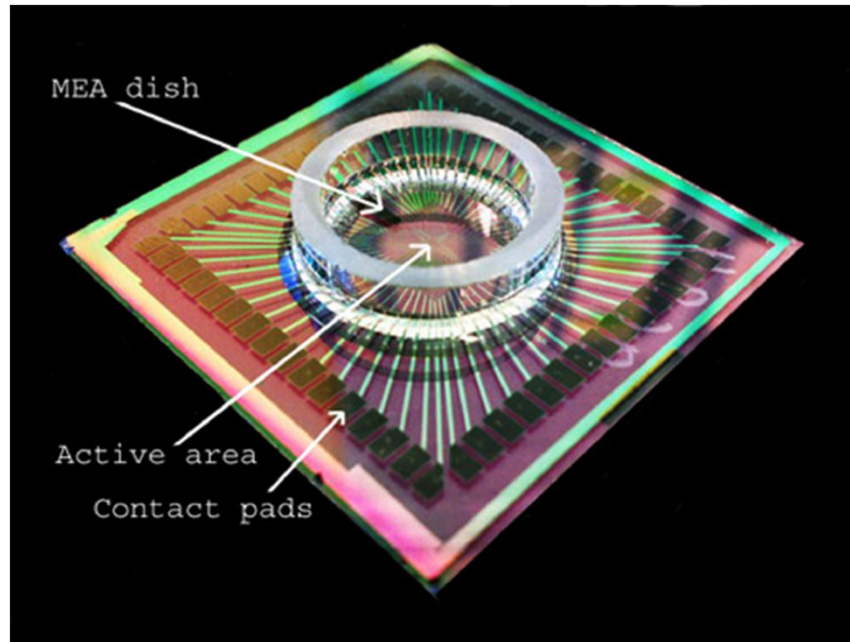

# 50 $\mu$ M carbachol-induced rhythmic activity in the hippocampus

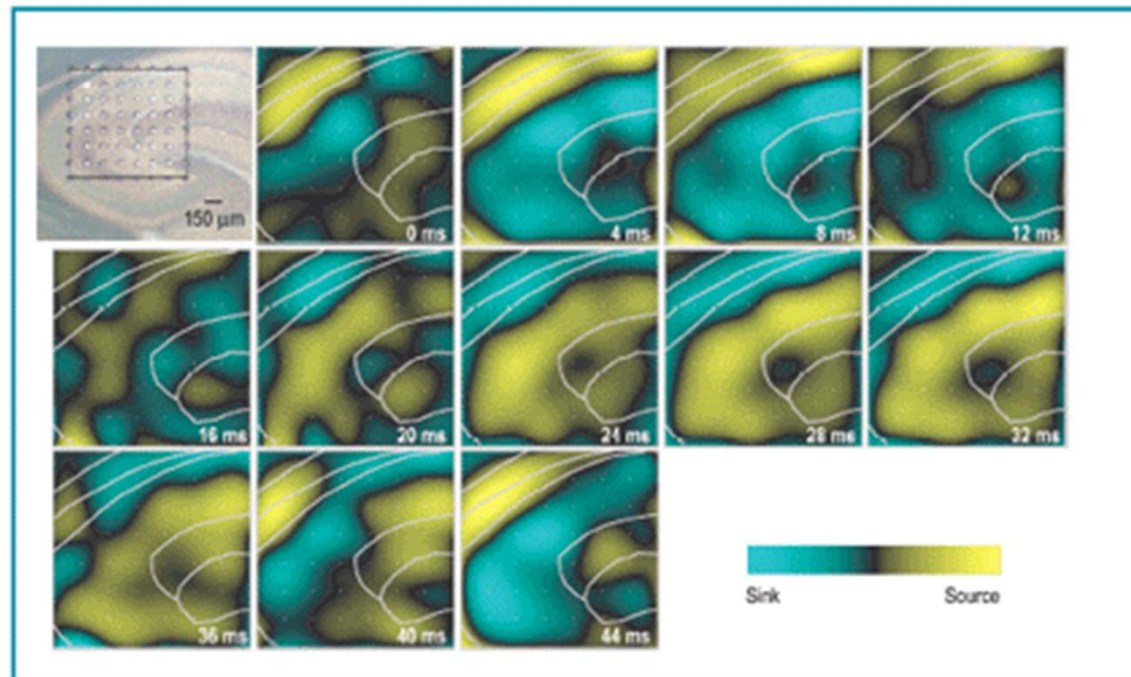
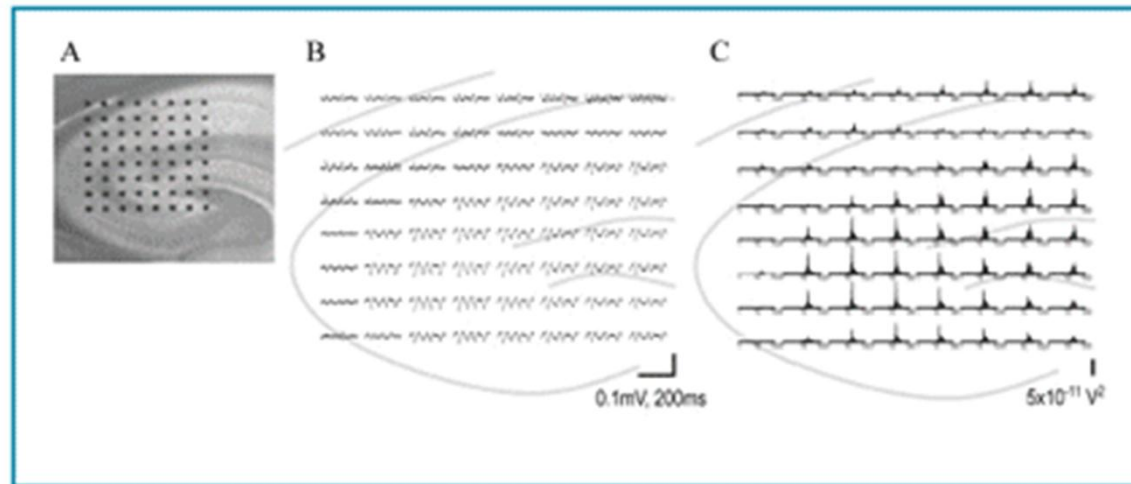

# Imaging voltage in neurons

## A

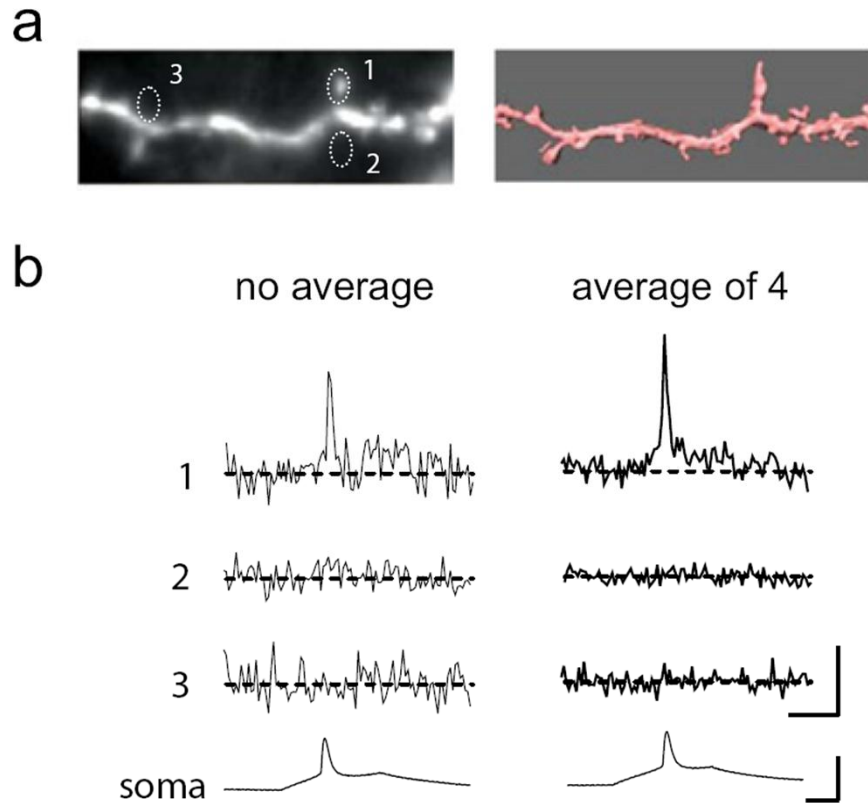

One-photon voltage imaging in individual dendritic spines of rat neurons with organic voltage-sensitive dye.

## B

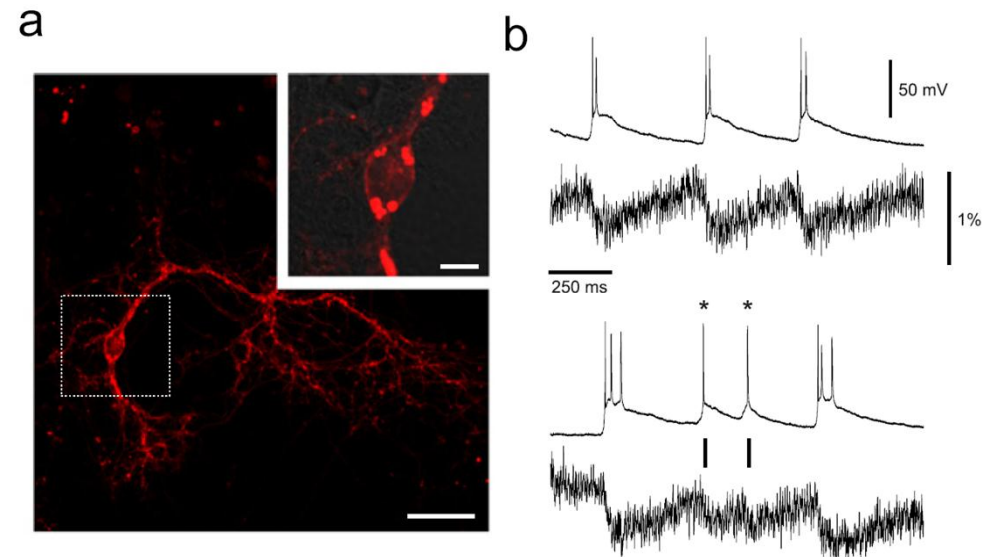

VSFP3.1\_mOrange2 transfected into a cultured hippocampus neuron and expressed in the soma, axon, and dendrites